

 **TADANO**
ATF-1300XL





MACROMOVE

GUINDASTES

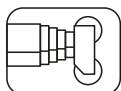

13,00/51,00m

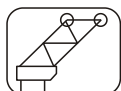

10,00/30,00m

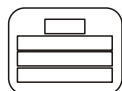

25t

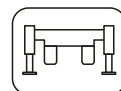

7,50X7,75m

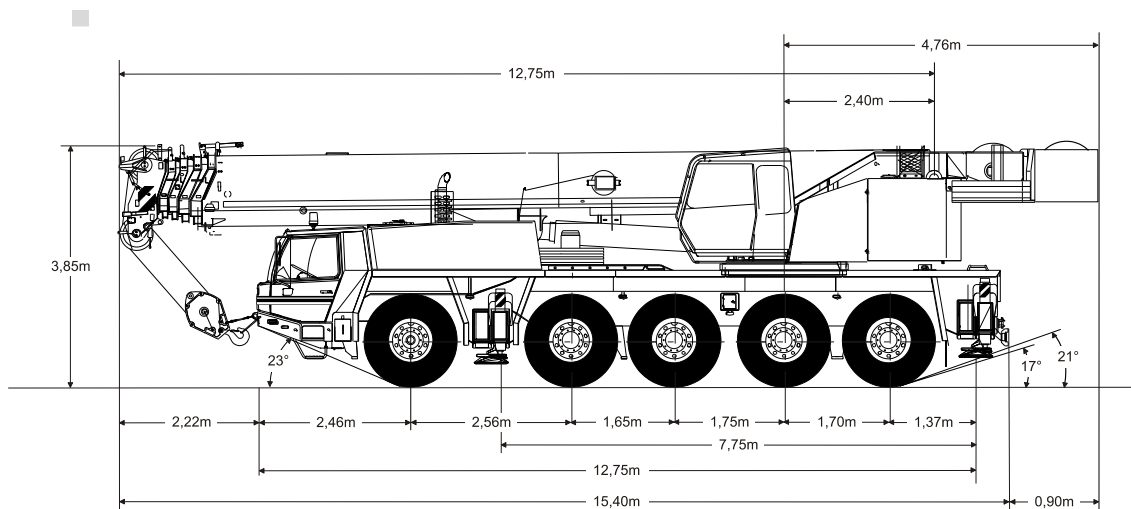



MACROMOVE

GUINDASTES

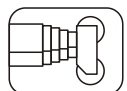

13,00/51,00m

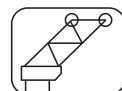

10,00/30,00m

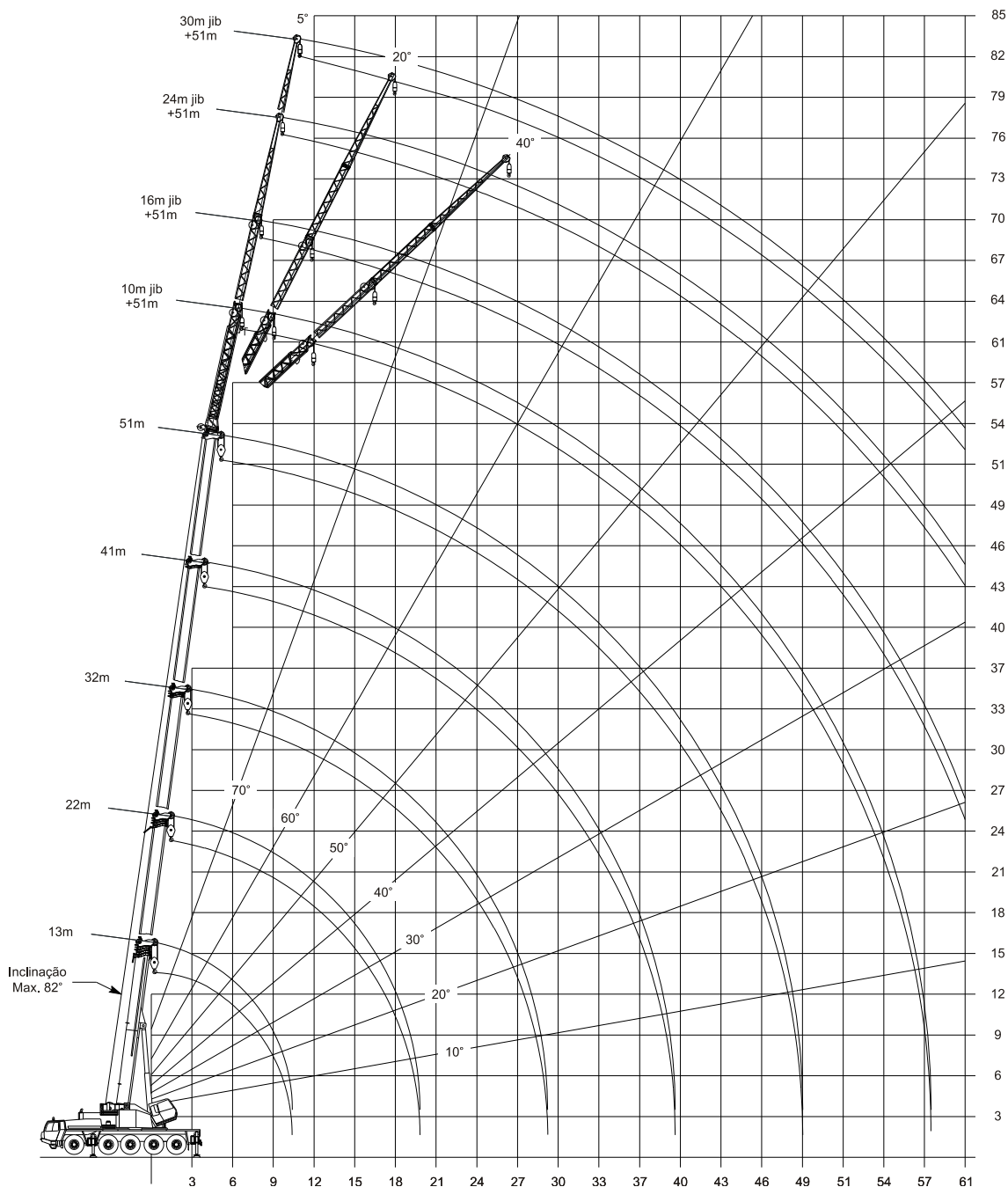



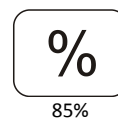
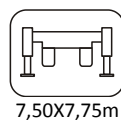
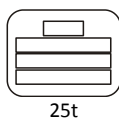
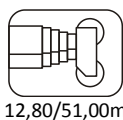

MACROMOVE

GUINDASTES



	13,00	17,00	22,00	27,00	32,00	37,00	41,00	46,00	51,00	
 3	130,00	87,80								 3
3,5	100,90	85,30	66,00							3,5
4,5	92,10	78,70	66,00	47,20						4,5
5	81,90	71,90	66,00	47,20						5
5,5	73,00	66,20	63,00	47,20	36,30					5,5
6	64,90	61,00	59,20	47,20	36,30	22,00				6
8	51,30	49,90	49,00	46,00	36,30	22,00	22,00			8
9	41,50	40,20	40,20	39,40	35,00	22,00	22,00	16,50	14,30	9
11		30,80	31,00	30,20	30,40	22,00	22,00	16,50	14,30	11
12		24,60	24,80	24,10	24,10	21,80	21,50	16,50	14,30	12
14		20,10	22,00	22,00	22,00	20,30	20,80	16,20	14,10	14
15			19,40	19,60	19,70	17,50	18,10	15,90	13,90	15
17			16,60	16,90	17,10	14,70	15,20	15,00	13,60	17
18			14,20	14,70	14,80	12,30	13,00	13,60	13,10	18
20				12,80	13,00	10,40	12,00	12,40	12,00	20
21				11,30	11,50	8,90	11,00	11,00	10,60	21
23				10,00	10,20	7,60	9,90	9,70	9,30	23
24				8,80	9,10	6,40	8,80	8,60	8,00	24
26					8,10	5,40	7,90	7,70	7,10	26
27					7,20	4,60	7,30	6,80	6,20	27
29					6,40	3,80	6,60	6,00	5,40	29
30						3,10	5,90	5,30	4,70	30
34							4,80	4,20	3,60	34
37							3,80	3,20	2,60	37
40								2,40	1,90	40
43								1,80	1,20	43
46									0,50	46



MACROMOVE

GUINDASTES

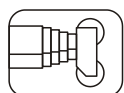

13,00/51,00m

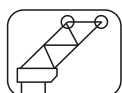

10,00/30,00m



25t

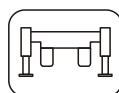

7,50X7,75m

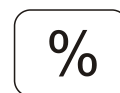

85%

	10,00	10,00	10,00	16,00	16,00	16,00	24,00	24,00	24,00	30,00	30,00	30,00	
	5°	20°	40°	5°	20°	40°	5°	20°	40°	5°	20°	40°	
11	10,00												11
12	10,00	8,30											12
14	10,00	8,30											14
15	9,80	8,00	5,70	5,50									15
17	9,50	7,70	5,80	5,50	4,60								17
18	9,30	7,40	5,60	5,50	4,60		3,60			2,50			18
20	9,00	7,10	5,50	5,40	4,50		3,60			2,50			20
21	8,80	6,80	5,40	5,40	4,40	3,30	3,50			2,50			21
23	8,50	6,70	5,20	5,20	4,30	3,30	3,40	2,70		2,50			23
24	8,00	6,60	5,10	5,10	4,20	3,20	3,30	2,60		2,40	2,00		24
26	7,00	6,40	5,00	5,00	3,90	3,10	3,20	2,50	2,00	2,30	2,00		26
27	6,30	6,20	4,90	4,90	3,90	3,00	3,10	2,40	1,90	2,20	1,90		27
29	5,50	5,80	4,80	4,80	3,70	2,90	3,00	2,30	1,80	2,10	1,80		29
30	4,80	5,20	4,70	4,50	3,60	2,90	2,80	2,20	1,80	2,10	1,70	1,50	30
34	3,60	3,90	4,20	4,20	3,40	2,80	2,50	2,10	1,70	1,80	1,50	1,30	34
37	2,60	2,90	3,10	3,40	3,20	2,70	2,30	1,90	1,60	1,60	1,40	1,20	37
40	1,80	2,00	2,20	2,60	2,90	2,60	2,10	1,80	1,50	1,50	1,30	1,10	40
43	1,10	1,30	1,50	1,90	2,30	2,40	2,00	1,70	1,50	1,40	1,20	1,00	43
46	0,50	0,60	0,70	1,30	1,60	1,80	1,70	1,50	1,40	1,20	1,00	1,00	46
49				0,80	1,00	1,20	1,20	1,50	1,30	1,10	1,00	1,00	49
52						0,60	0,70	1,10	1,20	1,00	0,90	0,90	52
55								0,60	1,00	0,50	0,80	0,80	55
58									0,80		0,50	0,70	58
61												0,70	61



Raio do centro do giro do guindaste ao centro da carga

Comprimento de lança

Comprimento de lança auxiliar jib

Quantidade de contrapeso utilizado

Distância entre patolas

Margem de segurança utilizada